

NEOGLOW LED

Installation Guide

BEFORE YOU BEGIN, READ INSTALLATION INSTRUCTIONS THOROUGHLY

- Install in accordance with the National Electric Code and local regulations
- This product is intended to be installed and serviced by a qualified, licensed electrician.
- DO NOT connect NeoGlow directly to 120VAC power
- DO NOT power NeoGlow while still in the spool or tightly coiled. Excess heat may cause damage.
- DO NOT submerge wet location NeoGlow in liquids. DO NOT install near chemically treated water or salt water.
- Keep this manual for the entire service life of the product. Pass installation manual along to future owner/user.
- Excessive shaking may damage the product.
- Ambient temperature must be maintained between 23°—113°F. Keep away from direct heat sources.
- Ensure applicable wire is installed between driver, fixture, and any controls in between. When choosing wire, factor in voltage drop, amperage rating, and type.
- NeoGlow must be handled with care. Excessive handling, bending, and pressure may damage the product, voiding the warranty.
- Each NeoGlow product has a different power consumption and run length that must be individually wired to a compatible driver, low voltage (PWM) control, Magnetic Dimmable Driver (MD Series), or Color Controller.
- NeoGlow can only be operated between altitudes of -65—6562 feet.

INSTALLATION

Prior to installation, ensure all components of the system are compatible. Configure and pre-test you LED system prior to permanent installation to ensure all components are operating correctly.

1. Turn power OFF at the main breaker before servicing or installing SlimFlex.
2. If using a stand-alone LED power supply (such as illuminFx's CV or MD series) - Determine a well-ventilated, accessible location. Ensure applicable wire is installed between driver, fixture and any controls in between.
3. If using a provided illuminFx control box (RIO Spectrum Select, Color Select or Color Select PLUS control centers) - Determine a well-ventilated, accessible location. Ensure applicable wire is installed between driver, fixture and any controls in between.
4. Cut at cutmarks on NeoGlow and seal all exposed sections of tape with silicone sealant and end caps. See 'CONNECTIONS' on page 2-3.
5. Mount NeoGlow to desired surface. Attach additional wiring and accessories to tape leads using provided connectors.
6. Harness all wires with plastic cable ties/staples, starting 2-4 inches from NeoGlow and every 4 feet afterwards to ensure connections do not detach from NeoGlow from excess pressure.
7. Connect compatible drivers and lighting controls. See 'COMPONENT INSTALLATION GUIDES' for detailed wiring connections.
8. Review the entire system. Ensure all polarities are correct and the connectors are secure and water tight.
9. Turn power ON at the main breaker. If system is not functioning properly, turn power OFF and see 'TROUBLESHOOTING'



IMPORTANT

Damages caused by disregard of this user manual are not subject to warranty replacements. IlluminFx will not accept liability for any resulting defects or problems.

CUTTING

NeoGlow can be cut in the field. Make sure to cut ONLY on the provided markings (figure 1). NeoGlow can be cut approximately every 4 inches. Use a set of snips and make a straight cut directly through the product.



figure 1

MOUNTING CHANNEL

The UC-NG08-100 mounting channel is designed specifically for IFX NeoGlow product. It is made of aluminum and comes in 1m sections that can be used in full lengths or cut into sections.



90° Installation

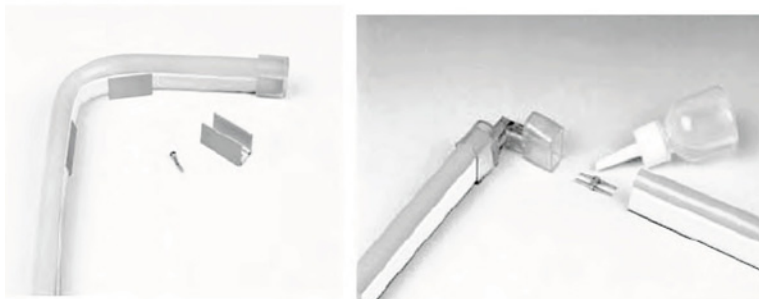

180° Installation



OTHER MOUNTING OPTIONS

NeoGlow may also be mounted with a silicon adhesive to any number of surfaces to allow it to curve and form different shapes. A few examples are below:

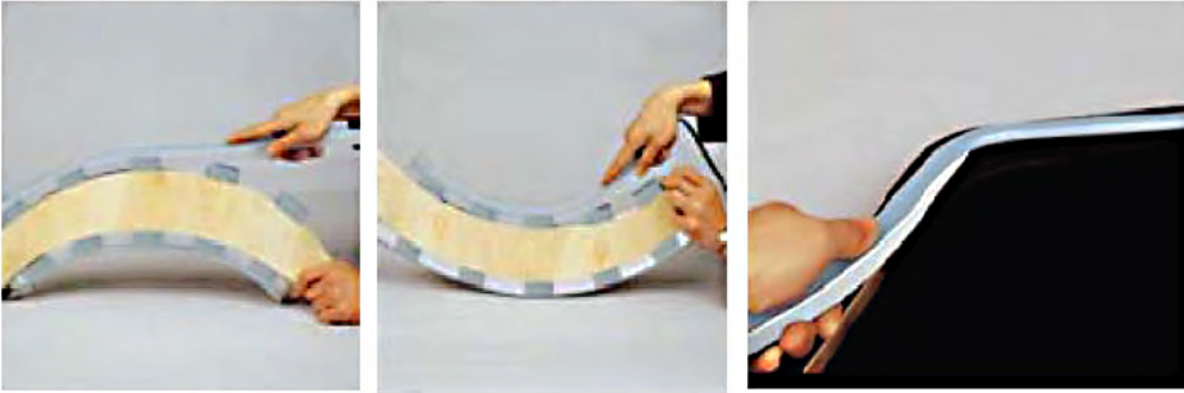

CONNECTIONS

A two wire connector will come attached to each 50' reel of NeoGlow. However, additional connectors of different types can easily be added using the bi-pin and its accompanying connector. The simple process is shown below. NOTE: Silicon adhesive should always be used to ensure watertight seal. Any new ends must be waterproofed with an end cap attached with silicon glue.

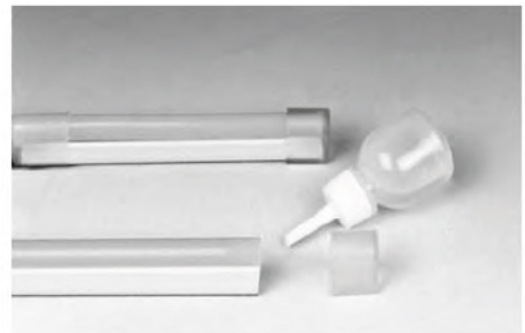
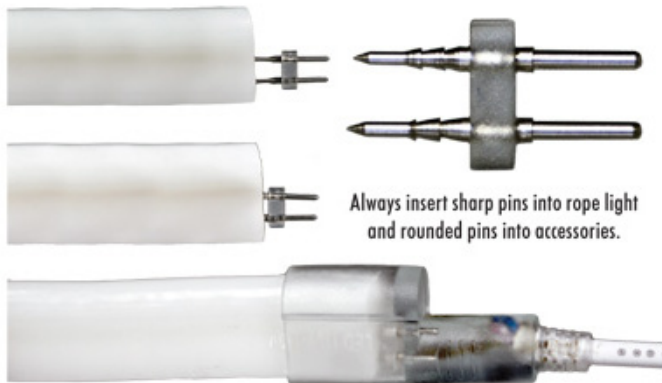

POWER SUPPLY

NeoGlow LED light operates at 24v DC; please check specific NeoGlow type for wattage. It is important to use a regulated DC power supply such as **illuminFx's CV and MD series power supplies**.

Please remember that this is a low voltage product and consult electrical codes when selecting appropriate wire. Power draw restricts the maximum length of NeoGlow (50ft). **CAUTION : DO NOT** exceed maximum length. Doing so will result in NeoGlow failures.

COMPONENT INSTALLATION GUIDES

Single Color NeoGlow

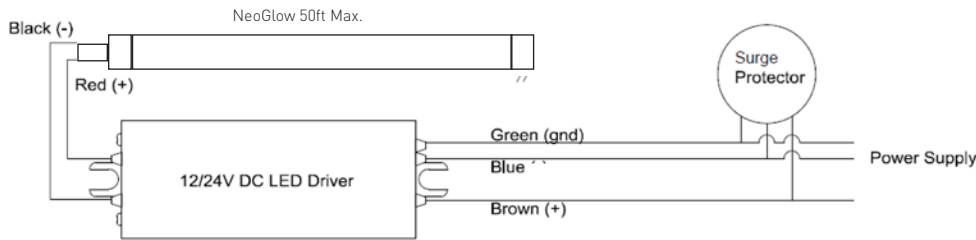

RGB NeoGlow

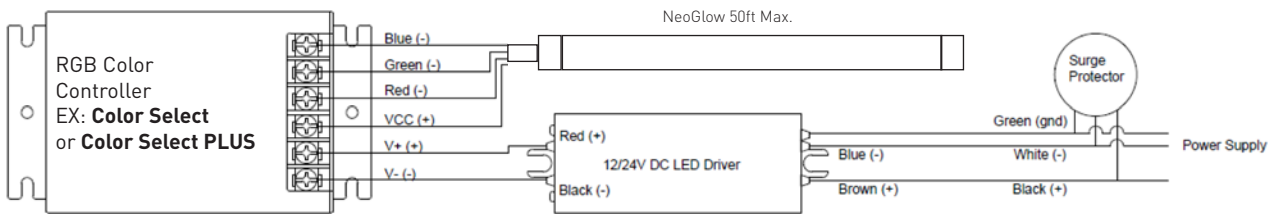

Single Color NeoGlow - Multiple Runs from Same Power Supply

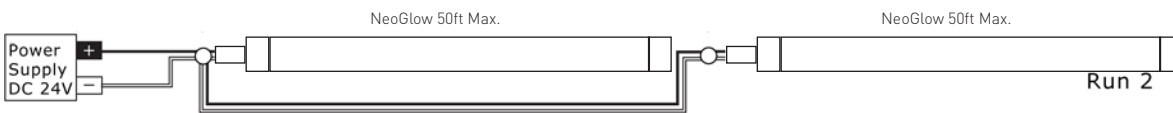

Single Color LED SlimFlex - Magnetic Dimmable Power Supply (see additional MD series cut sheets)

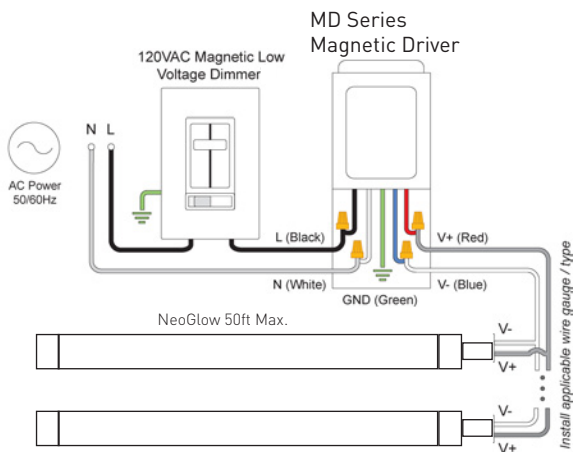

TROUBLESHOOTING

Before troubleshooting, ensure all items are compatible and the main power is turned ON

Loss of brightness in a run

Review maximum series run limits. Exceeding these limits will cause excess voltage drop, decreasing brightness as the run is extended.

Some LEDs are not functioning

Ensure all connections have been properly attached. Ensure each run of NeoGlow has not been bent excessively, which may cause components such as solder joints to detach from the board.

Lights are flickering

If using a dimmable system with a MD series driver, check applicable cut sheets to ensure you are using a correct dimmer. If lighting continue to flicker, check for loose connections.

Lights are turning on/off repeatedly

Ensure the driver is not overloaded. An overloaded driver will trip the internal auto-reset repeatedly

RGB NeoGlow won't power on

RGB NeoGlow has 4 wires, all of which need to be going to the correct locations on the color controller. The black wire is the common wire, if it is not connected or loose, no power will make it to the LEDs.

RGB NeoGlow isn't showing a certain color or wrong color

Make sure you have the red wire going to the red input of the color controller. Same goes for blue, and green. If one isn't connected you will not get the color and if some are connected to the incorrect spot, you will get colors you weren't expecting.

ADDITIONAL SPECIFICATIONS

Power Supply	24vDC
Power Consumption	Max 2W per foot
Cutting Length	~4"
LEDs/section	8
LED to LED Distance	0.5"
Tube Diameter	0.55" (w) x 1.1" (H)
Max. Ambient Temp. (Ta)	113°F
Max. Housing Temp. (Tc)	122°F
Min. Distance from Flammable Surfaces	1-5/8'
Weight	17.5 pounds per roll
Max. Loading Length	50 feet (1 roll)

FOR MORE INFORMATION

Contact illuminFx Lighting Systems:

22 Harcourt Rd
Rochester, NY 14606

(585) 254 - 8010
www.illuminfx.com
info@illuminfx.com



illuminFx reserves the right to make changes to specifications at any time with or without notice