

Flex Light  
**NEOGLOW**  
**NGS1010**

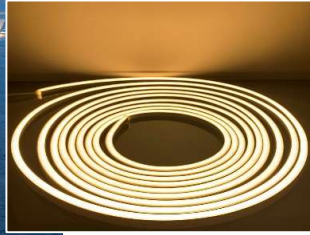

# NEOGLOW



Side Bending NeoGlow is a Flexible, low profile linear lighting product, perfect for applications requiring smooth illumination along a linear distance, like caps on seating walls, counter edges, steps, undercabinet, inside cabinet, deck railings and countless other applications.

- Features Designed for Professional Installation
- UL Listed
- Side bending
- Max run 32.9 Ft
- 3" cutting interval
- 2M (78") Lead wire
- Works on Standard 12VAC Landscape Lighting Transformer

## SPECIFICATIONS

Wattage	3W/FT   10W/M
Input Voltage	12VAC/DC Constant Current
Efficacy	75 LM/W @3000K
Color temp.	2700K   3000K   4000K
Cutting Interval	74mm   2.87"
LEDs/meter	126
Lumens	2700K - 225LM/ft   3000K - 225LM/ft 4000K - 252LM/ft
CRI	90+
Max run:	32.9 ft   10M
Profile Dim. WxH	10mm x 10mm   ~3/8" x 3/8"
Environment	IP65
Housing:	Silicone Extrusion with milky white diffuser
Dimmable:	Yes
Warranty:	5 Years indoor   3 years Outdoor

## DIMENSIONS

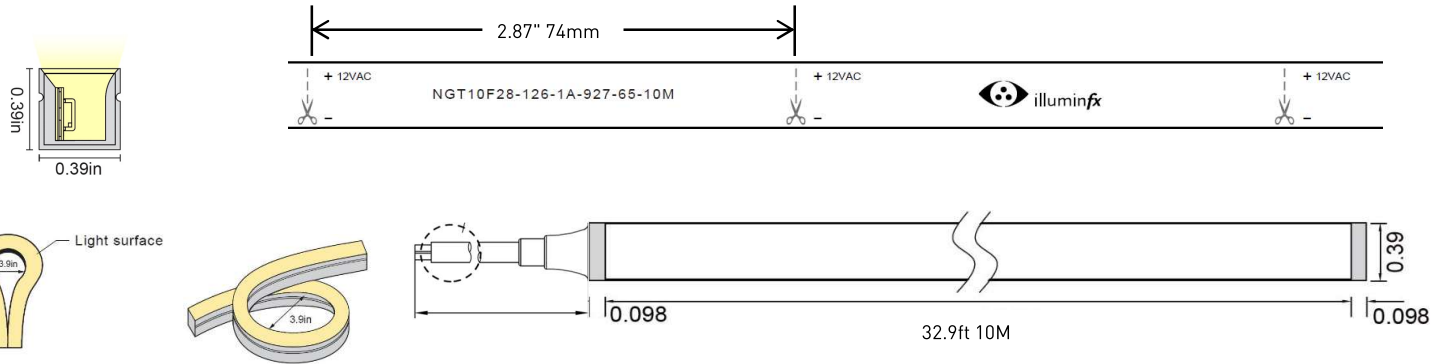

## ORDERING GUIDE

SERIES	LEDs/M	INPUT VOLTS	CRI/CCT	IP RATING	REEL PKG LENGTH
NGS10F28	126	1A	930	65	10M
	126	1A - 12VAC	927 - 2700K	65 - IP65 Outdoor	5M - 5M length
		2D - 24VDC	930 - 3000K		10M - 10M length
		940 - 4000K	CSTM - Custom Length		

illuminFx reserves the right to make changes to specifications at any time with or without notice



illuminFx Lighting Systems  
22 Harcourt Road | Rochester, NY 14606 USA  
www.illuminfx.com | info@illuminfx.com | 585-254-8010  
NGS10 e2401

# CONNECTORS IP65

# NEOGLOW NG10

Easy to use connectors for IP65 10mm x 10mm Side and Top bending NeoGlow.

- Features Designed for Professional Installation
- Strip to Wire, Strip-Wire-Strip
- wire gauge 22 AWG
- CE, RoHS, Reach
- 2M (78") Lead wire

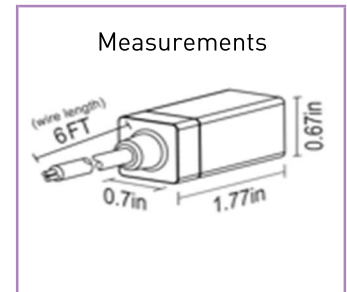
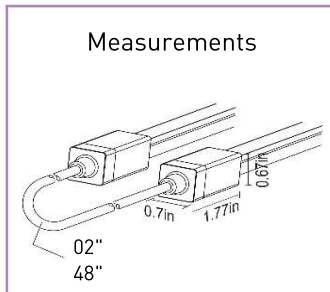
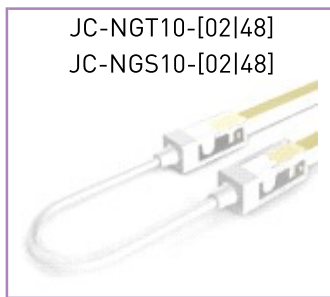
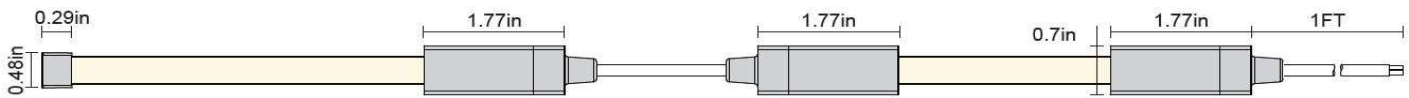
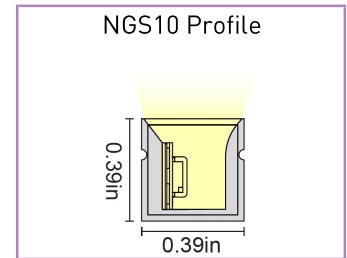
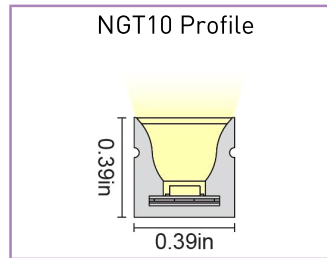

- EC-NG10 silicone end cap requires silicone glue adhesive
- JC-type connectors are available with 2" and 48" jumper wires
- NGS parts are for Side Bending and NGT parts are for Top Bending NeoGlow

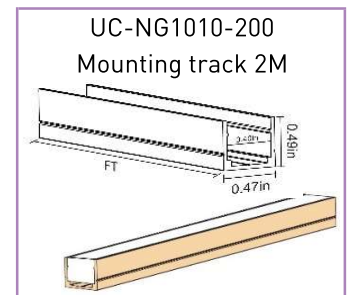
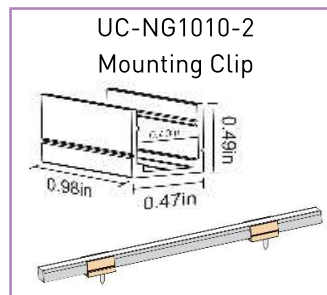

IlluminFx reserves the right to make changes to specifications at any time with or without notice